

IP65 LED Lighting

LL02H210 (Standard)

LL02H218 (Standard)

LL02I210 (Emergency)

LL02I218 (Emergency)

LL02J210 (Emergency + Heating System)

LL02J218 (Emergency + Heating System)



Product Features



Main Features

- Housing made of reinforced polyester glass fiber (GRP)
- High transparent and impact resistant PC diffuser
- Both standard and emergency modes available
- Automatic heating system for operations in extremely cold temperature down to -40°C
- IP65

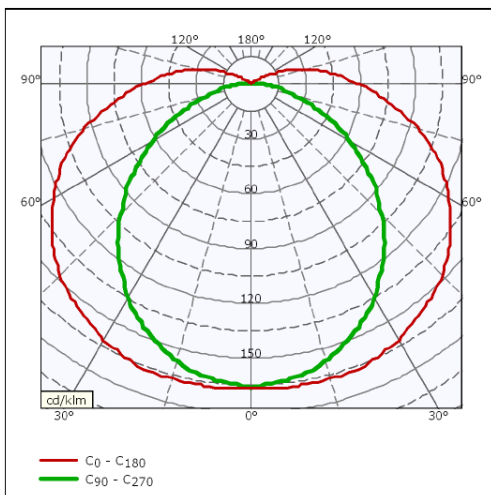

Characteristics

Item Spec.	LL02H210	LL02H218	LL02I210	LL02I218	LL02J210	LL02J218
Code	LL02H210-6	LL02H218-6	LL02I210-4/6	LL02I218-4/6	LL02J210-4/6	LL02J218-4/6
GE Item No.	445W2449P00 1 (120-230V), 445W2449P00 4 (100V) 445W2449P00 6 (120-230V)	452W5645P00 1 (1 cable gland) 452W5645P00 2 (2 cable glands)	445W2449P00 2 (120-230V), 445W2449P00 5 (100V) 445W2449P00 7 (120-230V)		445W2449P00 3 (120-230V) 445W2449P00 8 (120-230V)	452W5645P00 3 (1 cable gland) 452W5645P00 4 (2 cable glands)
Description	Light, LED, Standard SW/CW		Light, LED, Emergency Backup, SW		Light, LED, Emergency Backup, Heating System, CW	
Input Voltage	120-277V					
Voltage Range	100-300V					
Frequency	50-60Hz	50-60Hz	50-60Hz	50-60Hz	50-60Hz	50-60Hz
Rated Input Power	23W	45W	23W	45W	23W	45W
					30.5W (Heating System Work)	52.5W (Heating System Work)
Nominal Current	0.19A	0.38A	0.19A	0.38A	0.19A	0.38A
					0.26A	0.44A
Operation Temp.	-35~55°C	-35~55°C	-5~55°C	-5~55°C	-35~55°C	-35~55°C
Survival Temp.	-40~60°C	-40~60°C	-15~60°C	-15~60°C	-40~60°C	-40~60°C
Lamp Type	LED SMD, Cool White					
Lumen Output	2100lm	3700lm	2100lm	3700lm	2100lm	3700lm
Emergency Time	N/A	N/A	> 90Min	> 90Min	> 90Min	> 90Min
Battery Lifetime	N/A	N/A	5 years	5 years	5 years	5 years
Meas. Of lighting	L 670mm x W 164mm x H 102mm			L 1275mm x W 161mm x H 102mm		
Mounting distance	400±5mm			984±5mm		

** Code No. LL02H210-X, when X=2: CE approved; X=4: UL approved; X=6: CE+UL approved.

LL02H210/LL02I210/LL02J210:

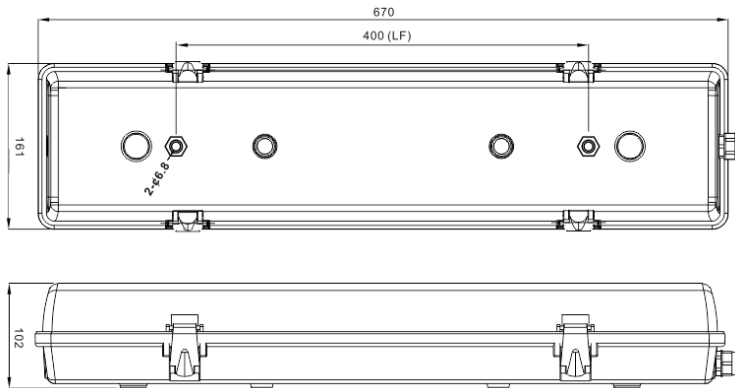

Mounting distance (LF): 400 ± 5 mm
2pcs mounting holes ready for M6 bolts.

LL02H218/LL02I218/LL02J218:

Mounting Solution 1

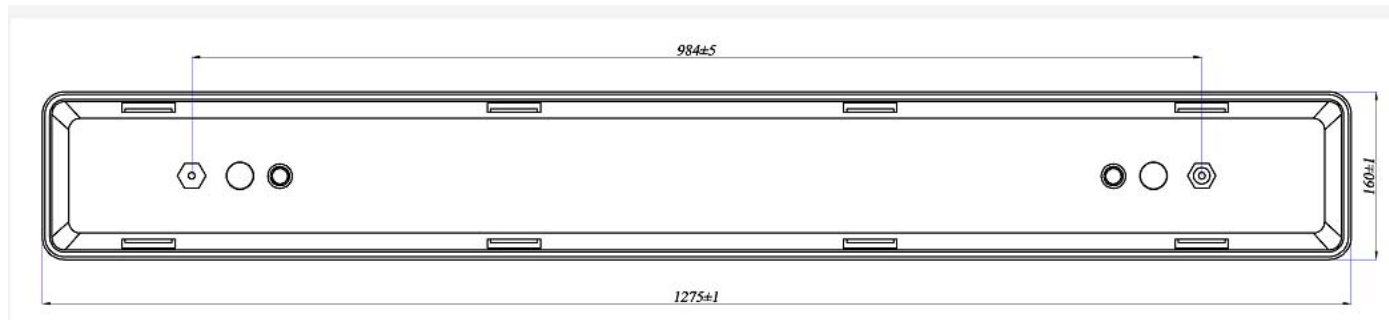

Mounting distance (LF): 984 ± 5 mm
2pcs mounting holes ready for M6 bolts.

Mounting Solution 2

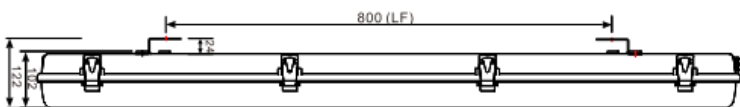

Mounting distance (LF): 800 ± 5 mm
2pcs mounting holes ready for M6 bolts.

Mounting Illustrations:

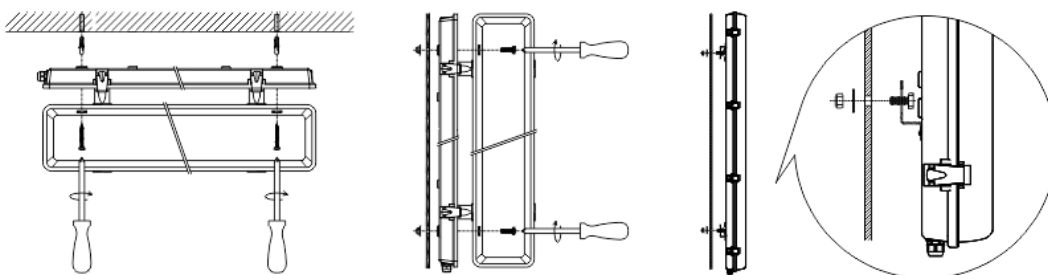

Phenix Part Number	GE Part Number	Number of glands	Gland location	Number of dummy plugs
LL02H210/LL02I210/ LL02J210	445W2449P001- 445W2449PP005	2	On the end adjacent to each other	1
LL02H210/LL02I210 /LL02J210	445W2449P006- 445W2449P008	3	Two on the end adjacent to each other Third on the opposite end of the other two glands	0
LL02H218/LL02I218 /LL02J218	452W5645P001/ 452W5645P003	1	On the end near the terminal block	0
LL02H218/LL02I218 /LL02J218	452W5645P002/ 452W5645P004	2	One on each end	0

The terminal board side shall be prepared with openings for installing of cable glands or a dummy plug (see sketch below). The lights have to be supplied with cable glands (M20, minimum clamping range 7 - 13 mm), associated locknuts (M20) and dummy plug (M20).

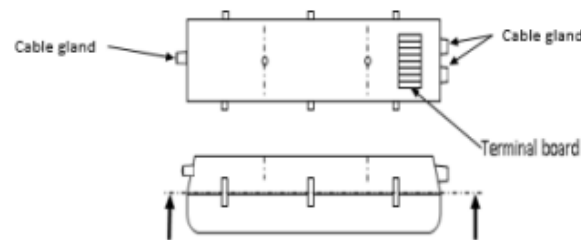

1 (or 2) cable glands on one side



1 or (0) cable gland on the other side



clips are not falling off

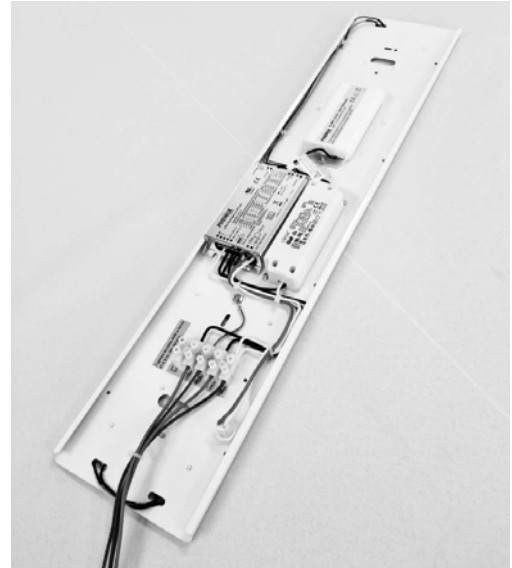

The heating system is used to ensure the luminaire to work well under extremely cold weather down to -40°C.

Input voltage: 120-277V

LL02H210
LL02J218

L1' = Normal Light (Switched)
N = Neutral
⊕ = Ground

LL02I210
LL02I218

L1' = Normal Light (Switched)
L1 = Emergency (Un - Switched)
N = Neutral
⊕ = Ground

LL02J210
LL02J218

L1' = Normal Light (Switched)
L1 = Emergency + heating (Un - Switched)
N = Neutral
⊕ = Ground

(RED: 100-120V
BLACK: 230-277V)

For emergency (or emergency + heating) luminaires, the following testing and maintenance shall be executed:

Press the LED Test Switch (TSW) to interrupt the power to led emergency driver and to force the luminaire into emergency mode, LED strip lamps are now being lit at a reduced light; the LED signal lamp (LSL) on the TSW turns off in emergency mode. After releasing the TSW, the luminaire returns to normal operation after a momentary delay, LED strip lamps are lit with full power, and the LSL turns on.



LED Test switch (TSW)

Note: If the end user needs the luminaire to go into the emergency mode only when the mains power is failed, an external switch should be added on the input terminal.

After installing the external switch, the luminaire need to be tested (both on and off status) if it complies the below situations:

When the mains power is on:

Turn on the external switch, the luminaire is in normal mode: All LED strip lamps are lit, and the LSL is lit, and the battery is being charged.

Turn off the external switch, the luminaire is in normal mode: all LED strip lamps are off, the LSL is lit, and the battery is being charged.

When the mains supply is failed:

No matter if the external switch is turned on or off, the luminaire goes into the emergency mode. All LED strip lamps are lit at a reduced output. The LSL is off and the battery is being discharged.

1. Instant Auto Test

When the system is connected well and powered on, the luminaire will auto test if the load and battery pack are connected well and if the battery is being charged normally. If there is any abnormal situation, the LED Signal Lamp (LSL) is flickering. When the abnormality is removed, the LSL indicates normally.

2. Preprogrammed scheduled Auto Test

- Carry out first monthly Auto Test after Initial power on for 24 hours to 7 days, afterwards, carry out a monthly Auto Test every 30 days.

- Carry out an annual Auto Test every 52 weeks after first powered on.

- Auto Test timing

To reduce the conflict that Auto Test is executed when the lighting is in use, the preprogrammed scheduled Auto Test will be executed 2 hours later than the normal operation is disconnected (switched off). For applications where lightings remain illuminated, the module will postpone the scheduled test accordingly, but should not later than the preprogrammed scheduled latest test time.

- Monthly Auto Test

Monthly Auto Test should be executed every 30 days and to test:

If the switchover of normal and emergency mode is normal;

If the emergency function and battery's charging and discharging condition is normal;

Auto Test time is about 30 seconds.

- Annual Auto Test

Annual Auto Test should be executed after 24 hours full charging and to test:

If the battery's voltage is equal or higher than the limit after 24 hours full charging;

If the emergency operation time is over 90 minutes;

If the battery voltage after 90 minutes emergency operation is still equal or high than 87.5% of the battery voltage before testing.

- During the Auto Test, in case a power failure happens and the power cannot be on till the Auto Test completes, then the Auto Test will be executed again 24 hours later after the power is on.

- If the emergency mode makes the battery discharged completely under the power off condition, then the preprogrammed scheduled Auto Test will resume the first time when the power is connected.

3. Manual Test

- Press LED test switch (LTS) one time, then go into emergency mode and back to normal mode rapidly.

- Press LTS 2 times continuously within 5 seconds, then go into monthly test. After finish, the next monthly test will count from this date.

- Press LTS 3 times continuously within 5 seconds, then go into annual test. After finish, the next annual test will count from this date.

- During the manual test, press LTS 3 times within 5 seconds, then the manual test can be terminated. (The preprogrammed scheduled Auto Test time will not change)

4. LED Signal Lamp (LSL) indication

- LSL on: Normal

- LSL off: Power failure

- LSL gradual change: In testing

- LSL flickering: Abnormal

Packing Details

No.	Item No	Outer Carton L (CM)	Outer Carton W (CM)	Outer Carton H (CM)	Qty/CTN (PCS)	N.W/CTN (KGS)	G.W/CTN (KGS)
1	LL02H210	70	37	25.5	4	16.5	18.2
2	LL02H218	130.5	37	25.5	4	19.8	21.3
3	LL02I210	70	37	25.5	4	17.7	19.4
4	LL02I218	130.5	37	25.5	4	20.8	22.3
5	LL02J210	70	37	25.5	4	18.5	20.4
6	LL02J218	130.5	37	25.5	4	21.5	22.8

➤ **Wind power system**



➤ **Ships**



➤ **Freezers**



➤ **Any other harsh indoor and outdoor locations**

